

Wireless Gateway

MODEL	DESCRIPTION
iSMA-B-W0202	Wireless gateway for Modbus RTU/ASCII

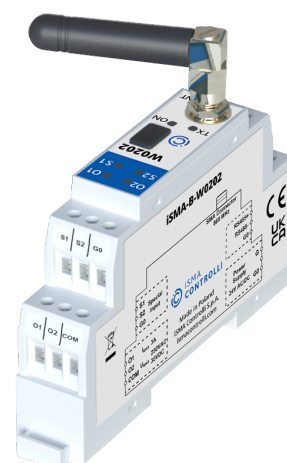

APPLICATION AND USE

W0202 is designed to allow the extension of the RS485 bus using a wireless technology wherever the use of network cable is impossible or unprofitable. Two W0202 modules enable to create a wireless bridge for a serial bus by building a wireless remote island (one or more) for devices communicating via Modbus RTU/ASCII – e.g., MIX/MINI series I/O modules. The W0202, in addition to the RS485 port and wireless port, is equipped with 2 SI (special inputs) and 2 DO (digital outputs), which allow using the device as an I/O module or light controller communicating in Modbus RTU/ASCII. Algorithms implemented in the device allow the user to choose one of the different modes:

- Modbus bridge;
- Modbus bridge and I/O module (both DO work independent of the state of SI);
- Modbus bridge and I/O module with built-in algorithms for light, cooling, or heating control;
- Modbus bridge and I/O module with present sensors support.

W0202 is also equipped with a mini USB port, which allows to configure it without an external power supply (the device is powered through the USB port). This solution gives users an easy way to carry out the tests within the existing facility.

FEATURES

- High transmit power and high sensitivity
- No license is required for the radio band
- USB for configuration
- RS485 port (Modbus)
- LEDs indicating the state of SI and DO
- Fast processor with ARM core
- 2 special inputs: voltage, resistance, dry contact, and fast counter up to 100 Hz save in EEPROM
- 2 digital outputs: relay, max. 3 A, 230 V AC/ 30 V DC
- 4 different operating modes
- Built-in present sensor support modes

TECHNICAL SPECIFICATION

DESCRIPTION		W0202
Power supply	Voltage	24 V AC/DC \pm 20%
Special inputs	Number of inputs	2
	Voltage input	Voltage measurement: 0-10 V DC Input impedance: 100 k Ω Measurement accuracy: \pm 50 mV
	Digital input	Output current \sim 1 mA
	Resistance input	Measurement of resistance: 0-1000 k Ω Resistance measurement method: voltage divider
	Temperature input	Measurement with RTDS (Real Time Digital Simulator) attached Accuracy: \pm 0.1 $^{\circ}$ C at 25 $^{\circ}$ C

The performances stated in this sheet can be modified without any prior notice.

DESCRIPTION		W0202
Special inputs	Measurement resolution	12-bit
	Fast counters	50 Hz/100 Hz
Digital outputs	Number of outputs	2
	Resistive load (AC1)	3 A at 230 V AC or 3 A at 30 V DC
	Inductive load (AC3)	75 VA at 230 V AC or 30 W at 30 V DC
COM	RS485 interface	Up to 128 devices
	Communication protocol	Modbus RTU/ASCII
	Port	Screw connector
	Baud rate	2400-115200
ANT	Radio interface	868 MHz frequency
	Sensitivity	-120 dBm
	Radio channels	1-8
	Encryption	AES-128
	External antenna	SMA socket
	Baud rate	1200-200000
	Max. output power	+20 dBm (100 mW)
USB	mini USB	For power and configuration
Ingress protection	IP rating	IP 40 for indoor installation
Temperature	Storage	-40°C to +85°C (-40°F to +185°F)
	Operating	-10°C to +50°C (14°F to 122°F)
Humidity	Relative	5 to 95% RH (without condensation)
Screw connectors	Type	Rising clamp screw terminals
	Maximum cable size	2.5 mm ² (18...12 AWG)
Housing	Material	Self-extinguishing plastic (PC/ABS)
	Mounting	DIN (DIN EN 50022 norm)
Dimensions	Width	17.00 mm/0.67 in
	Length	56.00 mm/2.20 in
	Height	90.00 mm/3.54 in

WIRING DIAGRAMS

Power Supply

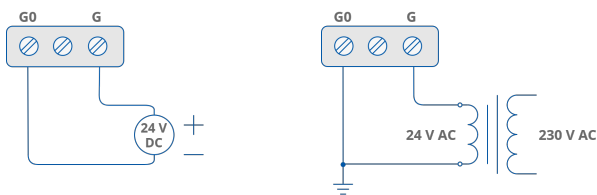

Communication

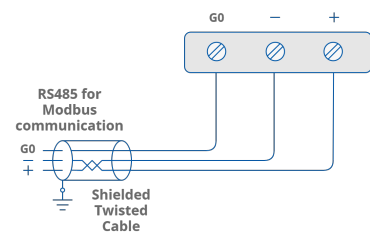

Special Inputs

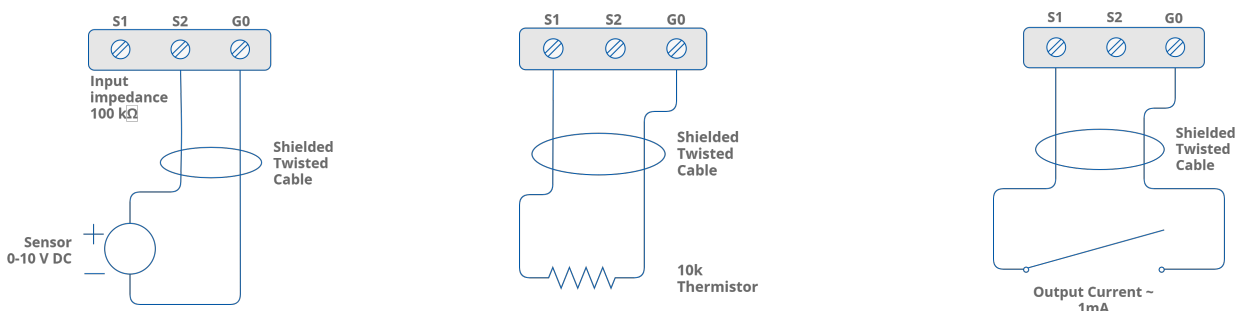

Digital Outputs

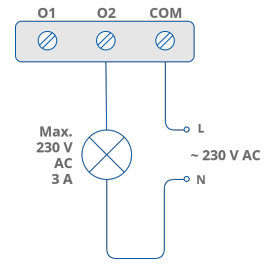
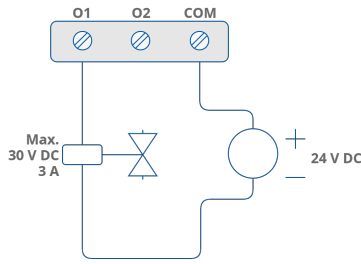

APPLICATION EXAMPLE

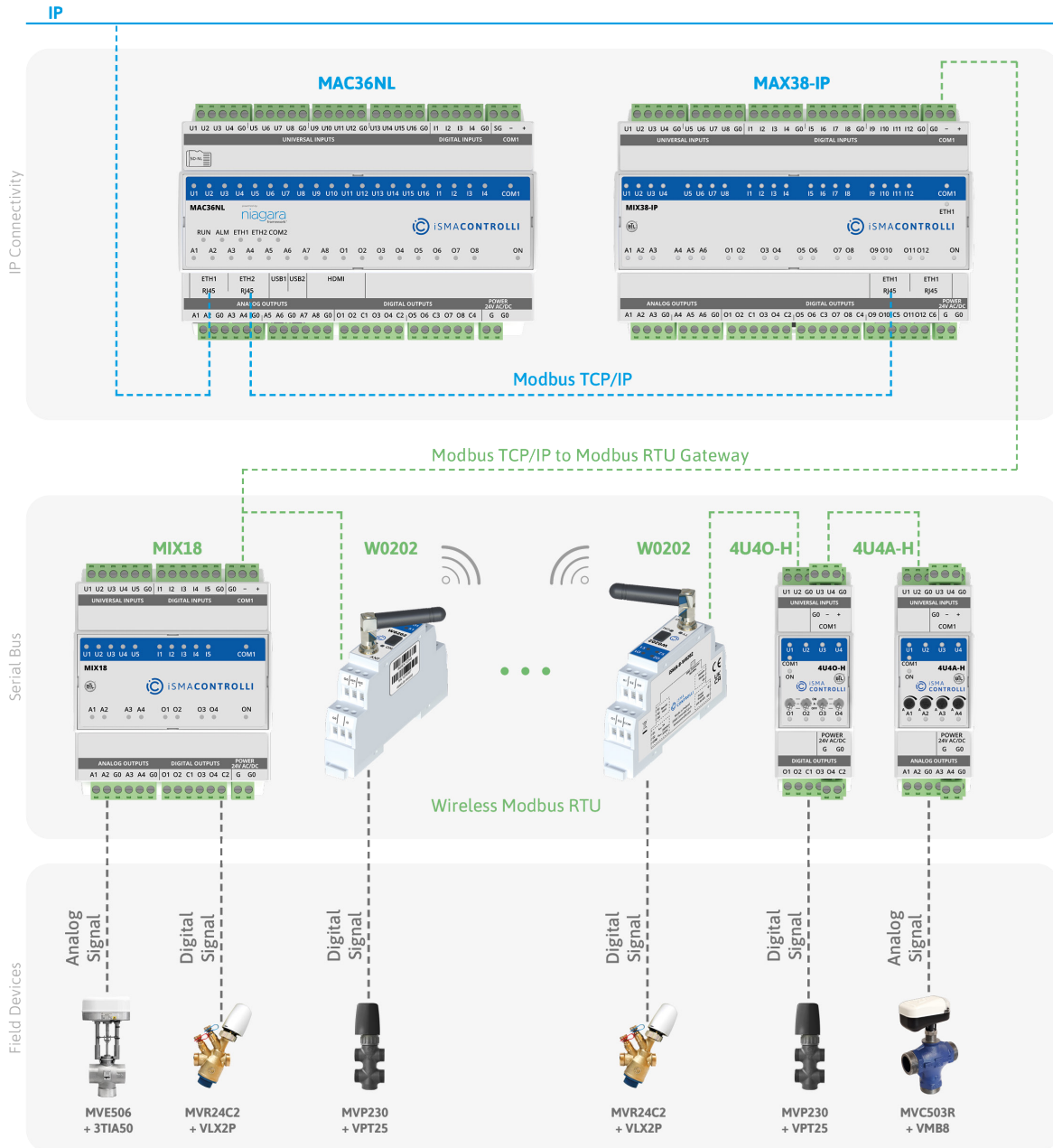

DEDICATED SOFTWARE



iSMA Configurator - configuration tool for non-programmable iSMA CONTROLLI devices

